

PVC-003 DATE: 8-19-2010 BY: RSK

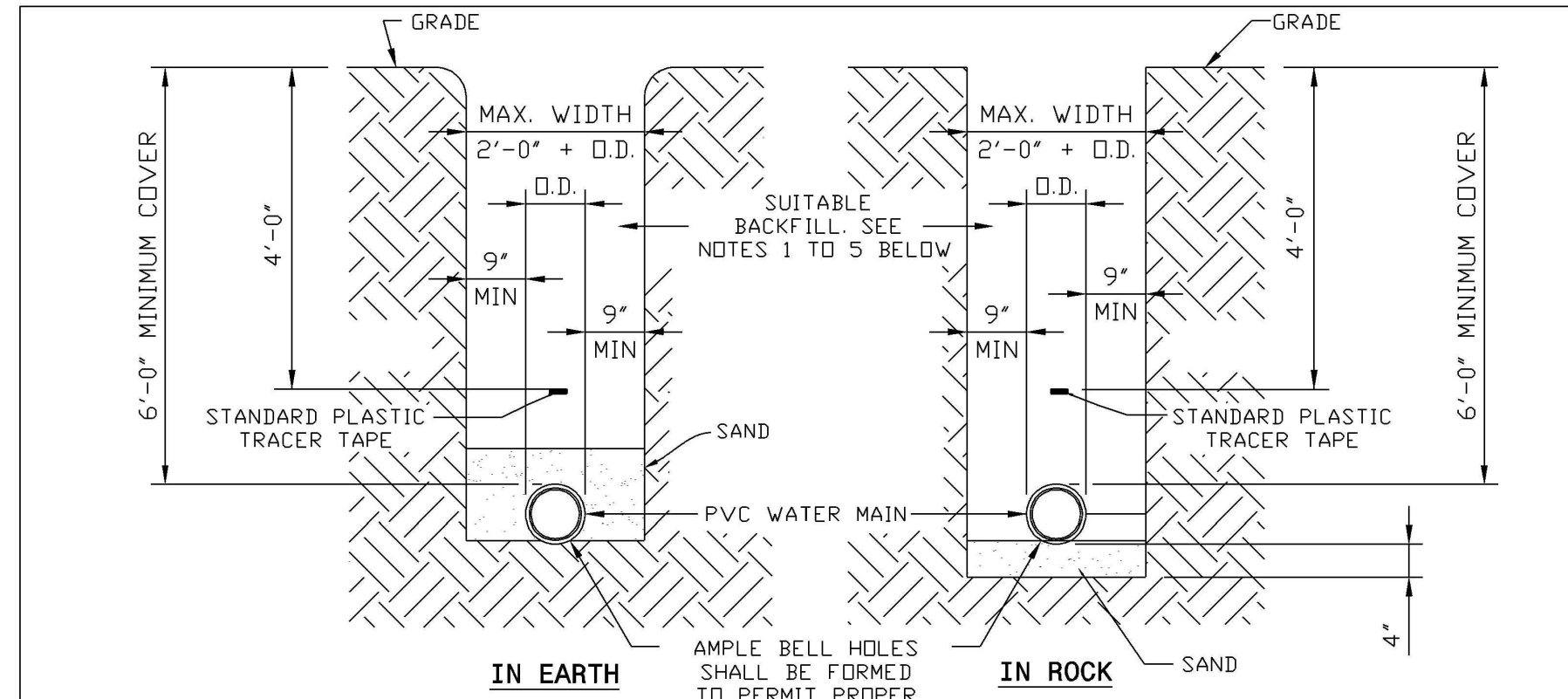

PVC-001 DATE: 11-1-09 BY: DR

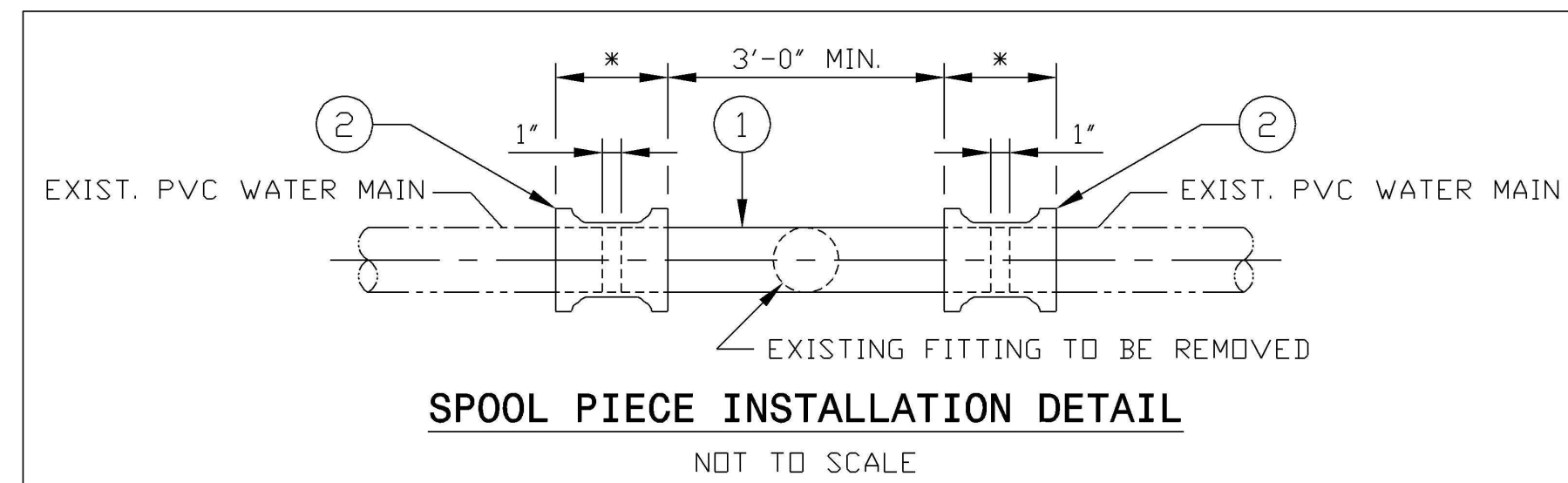

PVC-008 DATE: 6-11-2001 BY: RSK

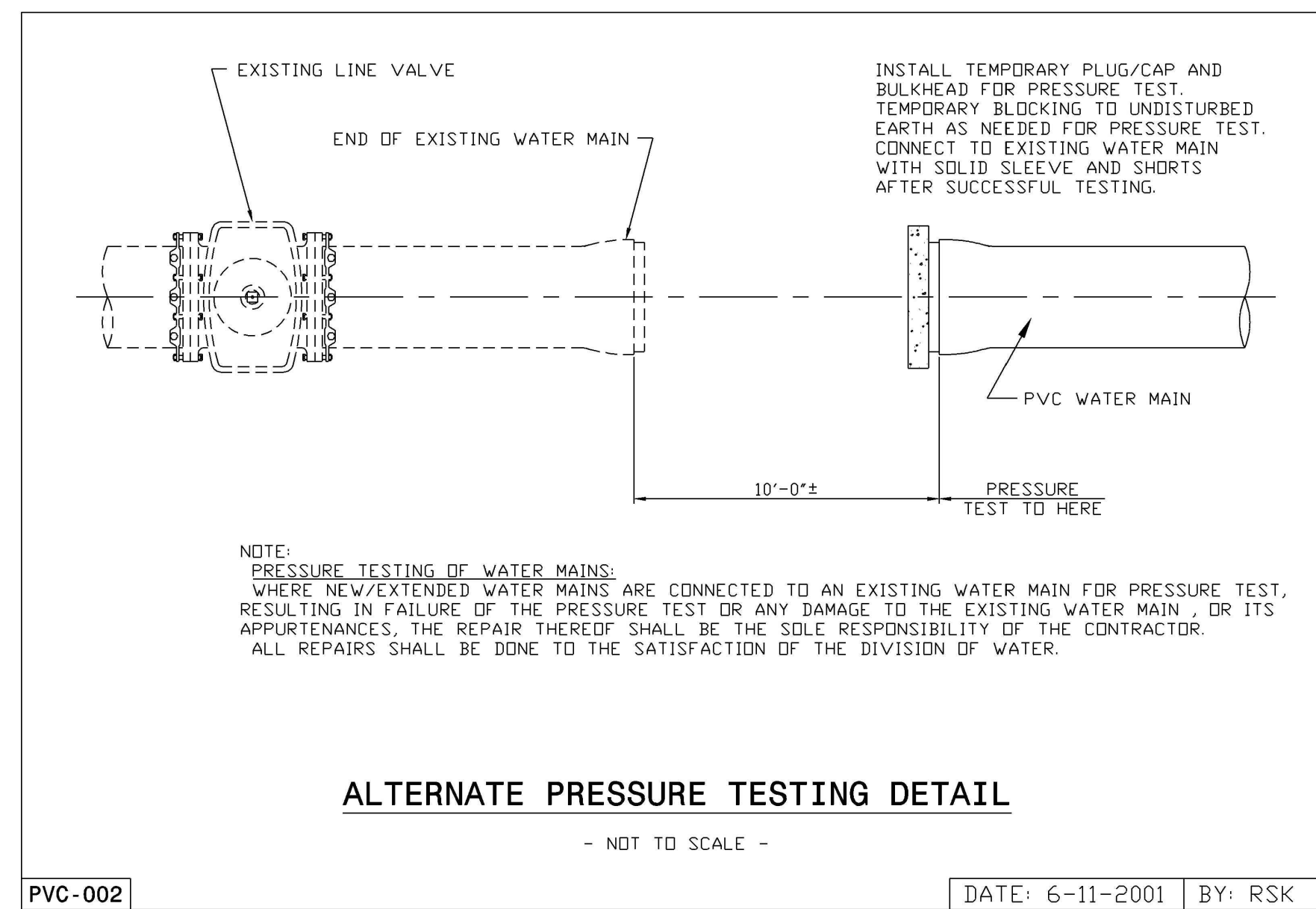

PVC-002 DATE: 6-11-2001 BY: RSK

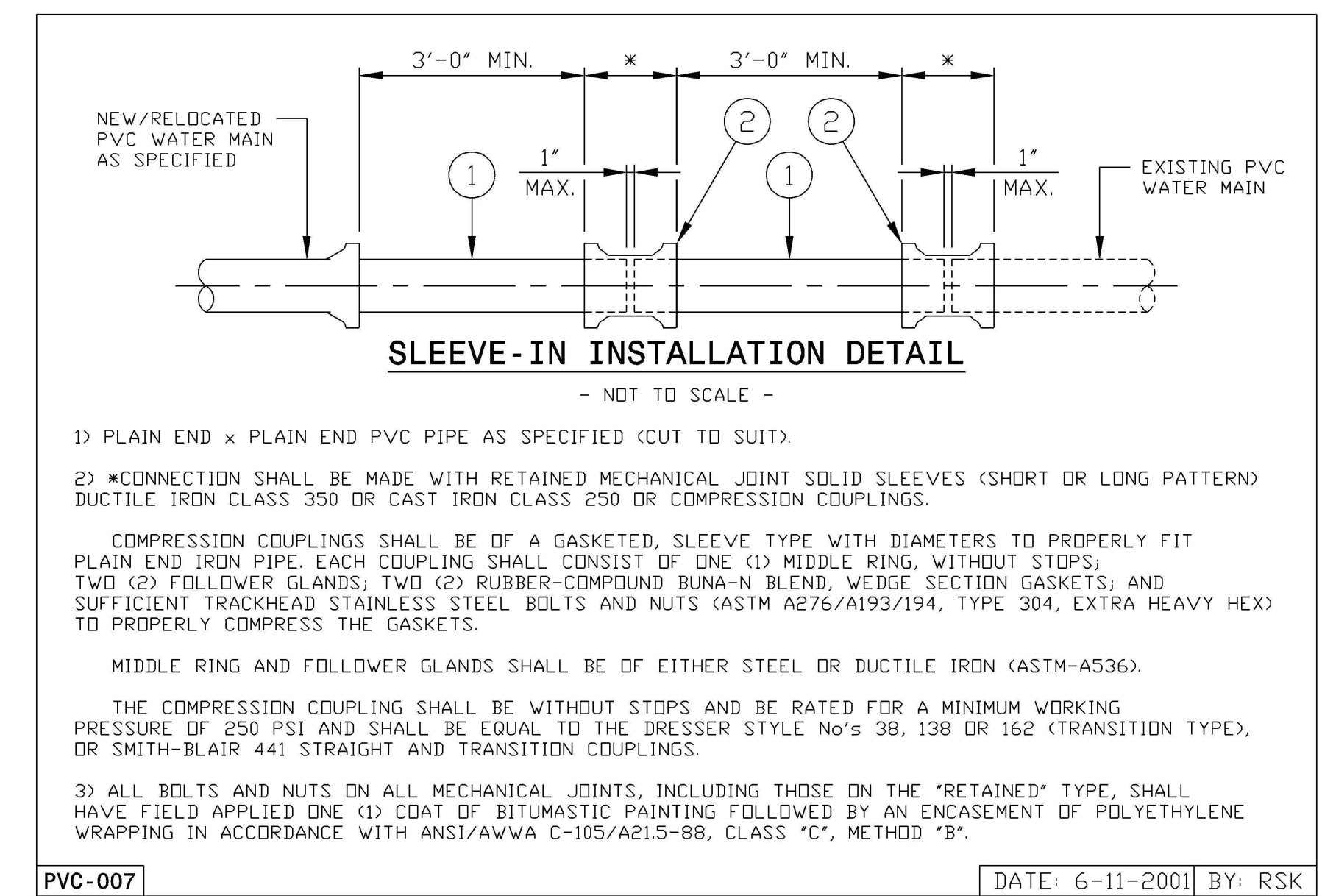

PVC-007 DATE: 6-11-2001 BY: RSK

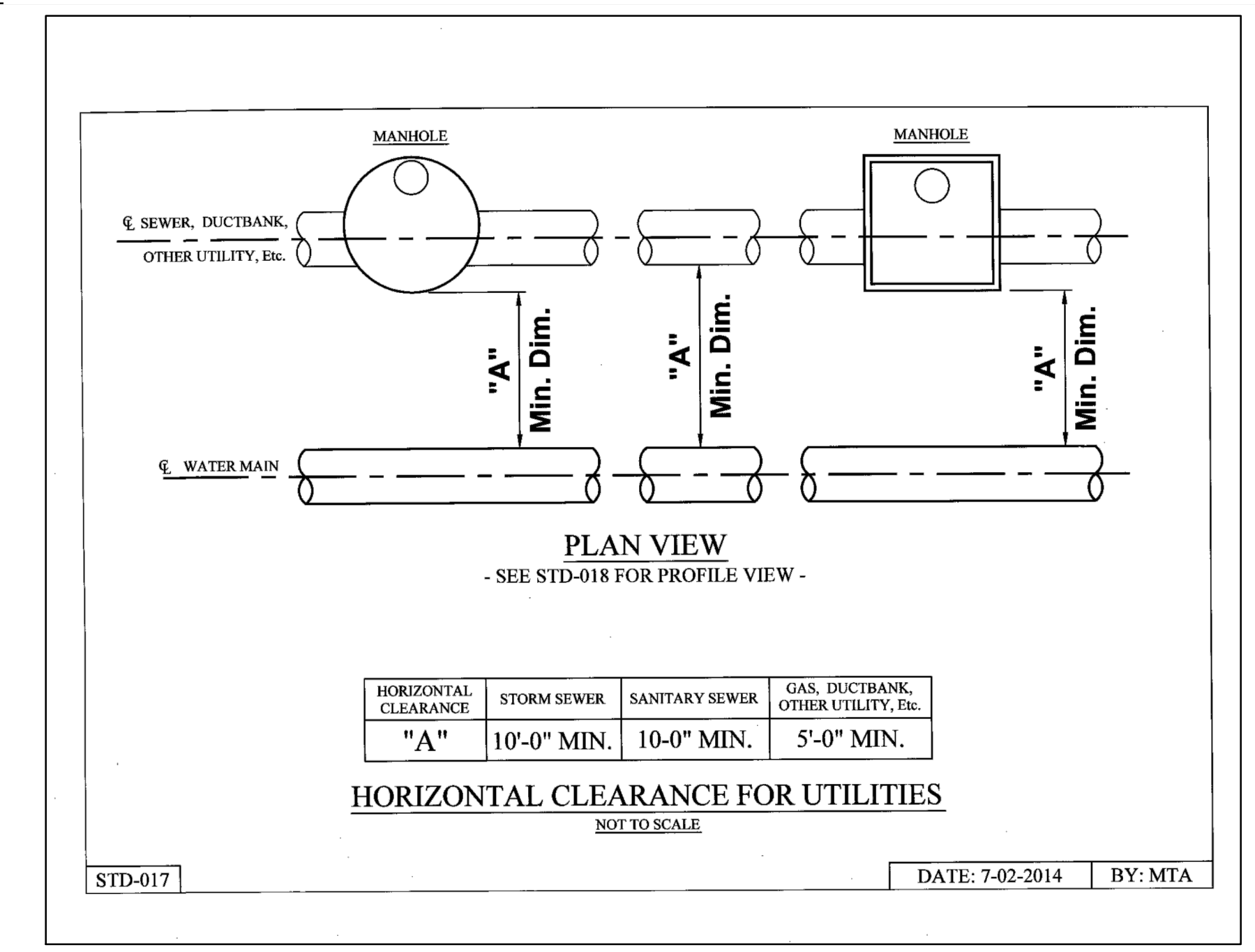

STD-017 DATE: 7-02-2014 BY: MTA

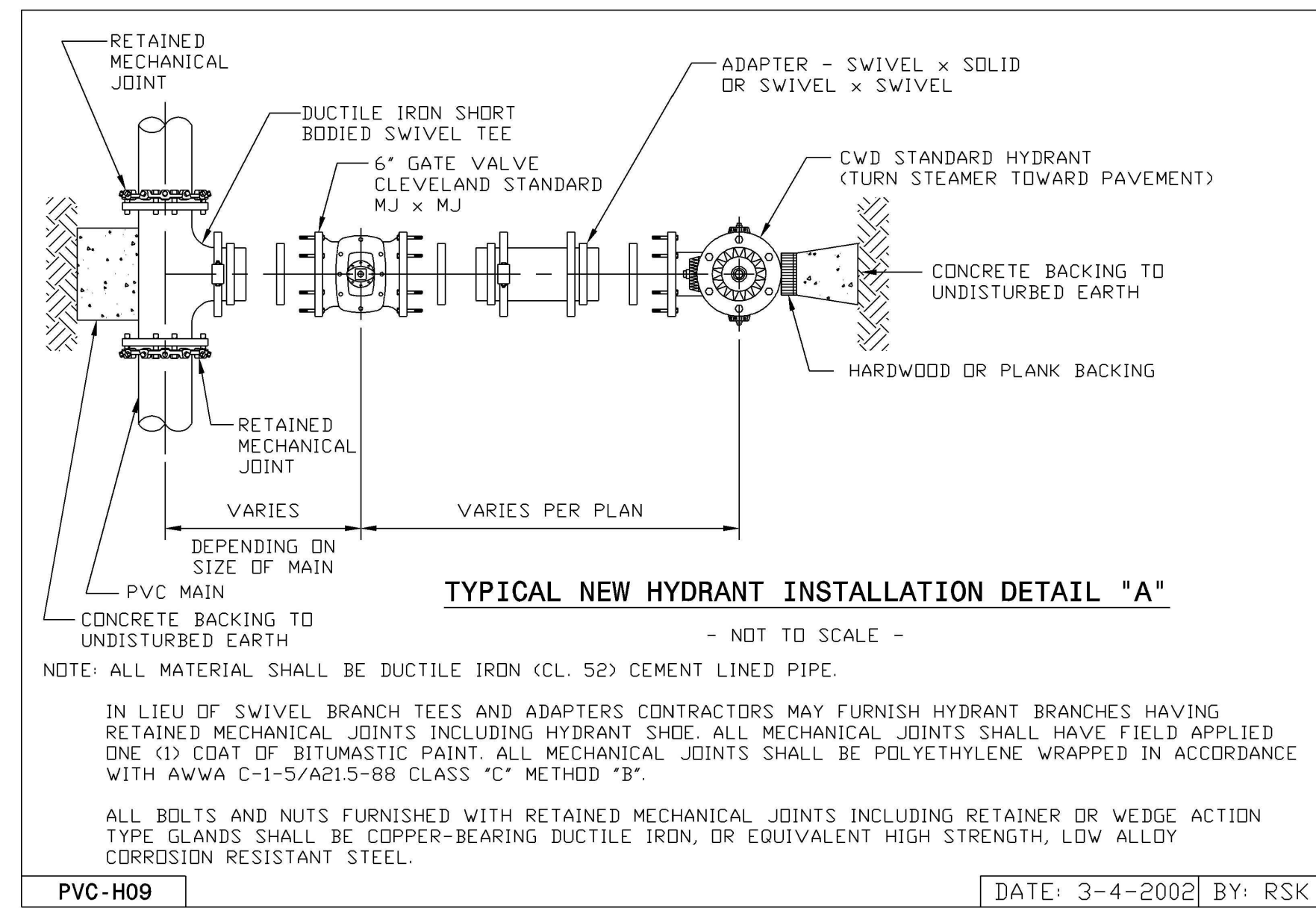

PVC-H09 DATE: 3-4-2002 BY: RSK

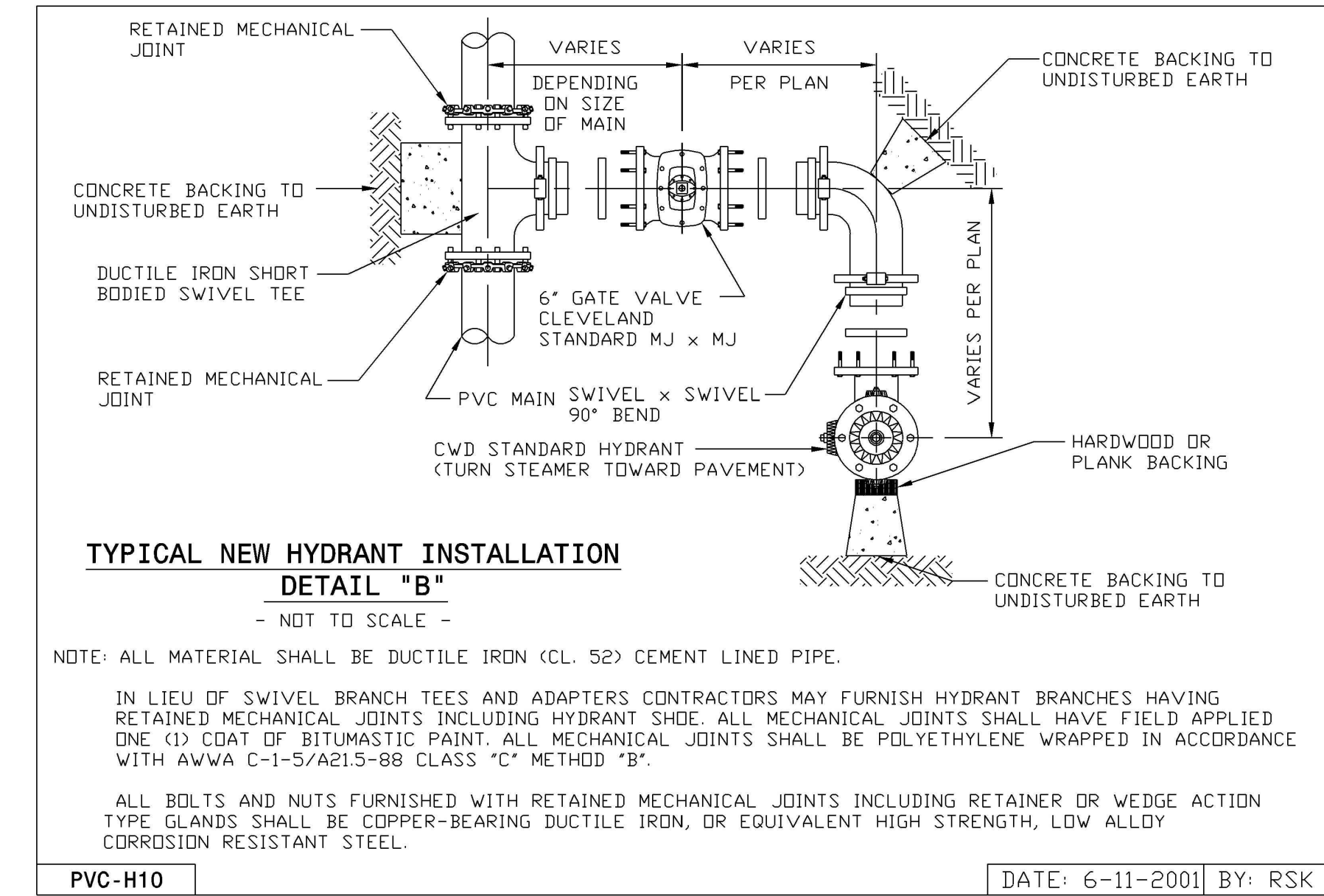

PVC-H10 DATE: 6-11-2001 BY: RSK

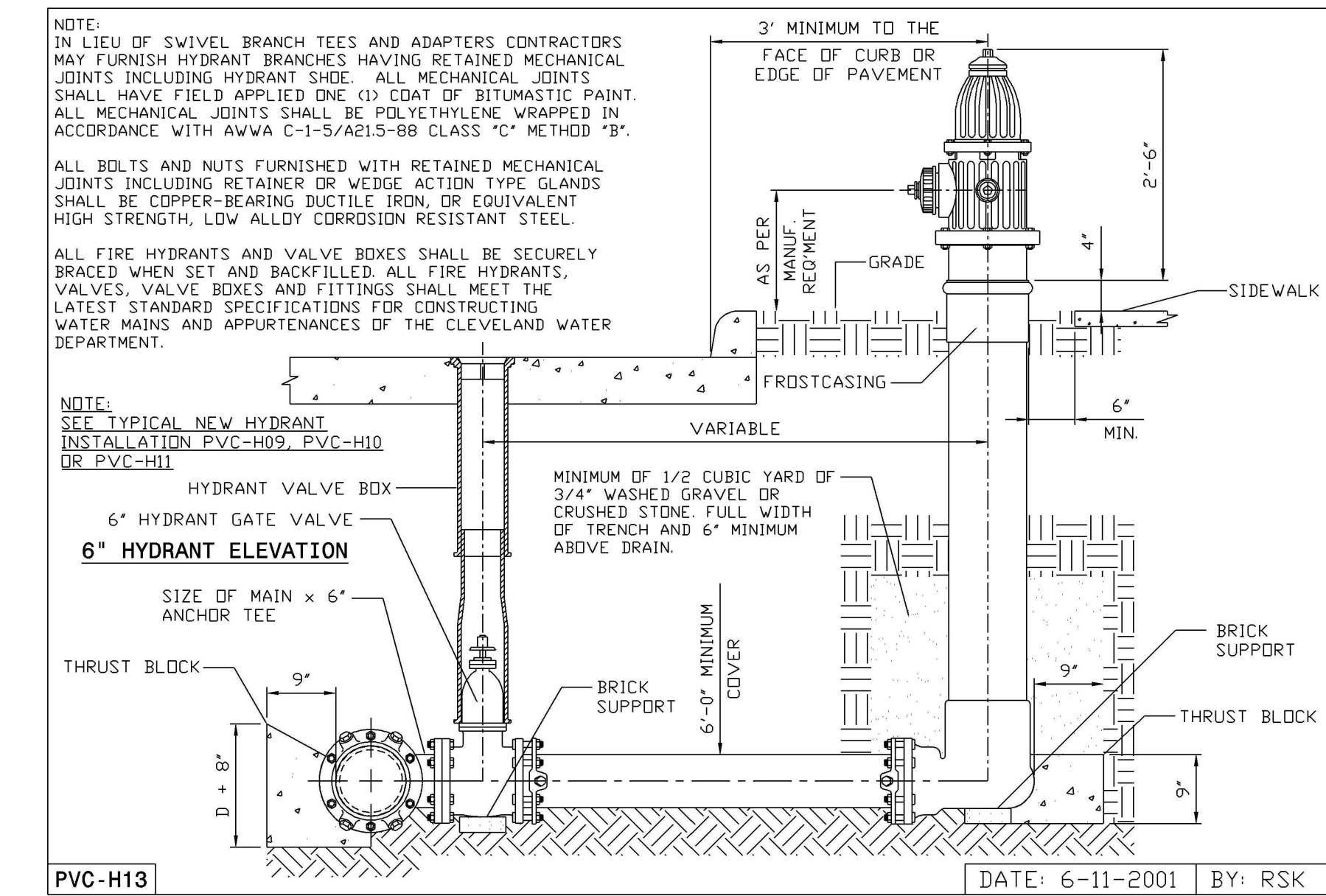

PVC-H13 DATE: 6-11-2001 BY: RSK

WEBER ENGINEERING SERVICES
 2555 Harville Rd., Suite B
 Rootstown, OH 44272
 www.WeberEngineeringServices.com
 330-329-2037
 matt@webercivil.com

STATE OF OHIO
 MATTHEW L. WEBER
 61709
 REGISTERED PROFESSIONAL ENGINEER

Reg. No.: 61709

Dunham Land Properties Inc.
 756 Ravenhill Drive
 Sagamore Hills, OH 44067
 Paul Karnow
 Ph.# (330) 468-2892
 Fax# (330) 468-2892

Issue Date

01-25-2016
02-05-2016
02-11-2016
02-25-2016
06-01-2016
06-29-2016
08-10-2016
09-08-2016
10-03-2016
10-10-2016
03-27-2017

HIDDEN RIDGE
 RESIDENTIAL SUBDIVISION
 DUNHAM ROAD

SITE DETAILS

C107B
 Project No. 2014-226